

Phase split of liquid–liquid two-phase flow at a horizontal T-junction

L. Yang¹, B.J. Azzopardi^{*}

Multiphase Flow Research Group, Nottingham Fuel and Energy Centre, School of Chemical, Environmental and Mining Engineering, University of Nottingham, University Park, Nottingham NG7 2RD, United Kingdom

Received 16 December 2005; received in revised form 3 August 2006

Abstract

This paper provides data on the split of liquid/liquid two-phase flow at a horizontal T-junction. Phase maldistribution was measured for kerosene–water flow at the T-junction with equal pipe diameters of 67.4 mm. Data were taken with both stratified flow with a mixture at interface and dispersed flows approaching the junction. The degree of phase maldistribution was not very great but preferential emergence of either phase from the side-arm was observed depending on the flow rates of the two-phases. There are similarities with the limited split data from liquid/solid flows and the degree of separation is seen to depend on the dispersed/continuous phase density ratio. The data were compared to predictions from the correlation by Seeger et al. The Seeger equation gives but reasonable agreement.

© 2006 Elsevier Ltd. All rights reserved.

Keywords: Liquid/liquid; T-junction; Horizontal

1. Introduction

When two-phase flow in a pipe encounters a T-junction, the two-phases very rarely emerge in the same ratio as they enter. This phase maldistribution has been known since the 1960s. Research on phase redistribution of two-phase flows at junctions has two motivations: One is to prevent the detrimental effect the maldistribution has on downstream equipment when a T-junction is used as a simple fluid divider; Another is to provide effective phase separation when the junction acts as a partial phase separator. For all these purposes it is essential to understand and predict the flow behaviour of the mixture at the junction for various equipment and operating conditions.

Studies of the phase redistribution have been reported for gas–liquid, gas–solid and liquid–solid flows but hitherto there has only been one study published on liquid/liquid flows. There is a substantial literature for gas–liquid two-phase flows with considerable understanding of the important parameters influencing the

^{*} Corresponding author. Tel.: +44 115 951 4160; fax: +44 115 951 4115.

E-mail address: barry.azzopardi@nottingham.ac.uk (B.J. Azzopardi).

¹ Present address: Jiangsu Polytechnic University, Changzhou, Jaingsu 213016, China.

phase maldistribution for some geometries and flow patterns. Significant quantities of experimental data for gas–liquid flow have been collected and considerable efforts in flow modeling have been made. Extensive reviews on this subject have been published by Azzopardi (1999) and Müller and Reimann (1991). Of most relevance to the present work will be the papers by Seeger et al. (1986) and Reimann et al. (1988) who reported data for steam/water at 100 bar (density ratio = 12.5).

Work on other phase combinations is more limited. Much of the published work on gas/solids flows concerns itself with the additional pressure losses across the junction. Morikawa et al. (1974) using 3.4 mm plastic particles considered symmetrical junctions where both outlets are at an angle to the inlet pipe. They found that 50% of the solids emerged from each outlet with little change even when the gas emerging from one outlet varied from 20% to 80%. In later work, Morikawa et al. (1978) who used 1.1 mm plastic particles and angles between one outlet pipe and the original direction of the main pipe of 0°, 15°, 30°, 45°, 65° and 90°. The equivalent angle for the other pipe was set at 30°, 60° and 90°. In this case the split of solids depended on the ratio of projected area of the side-arm considered to the cross sectional area of the inlet pipe. However, there was little effect on the diversion of gas. In contrast, the work of Lempp (1966) and Maeda and Ikai (1976), who used much smaller particles, reported that the division of solids depended strongly on the division of gas.

The split of liquid/solids flows at T-junctions was examined by Nasr-El-Din and Shook (1986) and Nasr-El-Din et al. (1989). The former worked with a vertical inlet pipe whilst the latter looked at a horizontal inlet pipe. When the side-arm was horizontal they observed only small deviations from an equal split. There was a systematic effect of particle size in the range studied but only a small effect of mixture velocity. Nasr-El-Din et al. also considered the effect of side-arm orientation (studying vertical up and vertical down as well as horizontal). They found the solids were preferentially extracted through the downward side-arm and liquid preferentially through the vertically upward side-arm. The maldistribution increased with decreasing liquid velocity. It also increased with increasing particle size but decreased slightly with particle concentration.

The only publication on liquid/liquid division at a T-junction is that of Yang et al. (2006) who examined a horizontal main pipe with a vertically upwards side-arm. That work was motivated by the design of compact phase separators which explains the geometry selected. They found that good separation, i.e., a high level of phase maldistribution, was obtained when the inlet flow was stratified. The separation was less good when the flow was dispersed.

In considering the behaviour of a liquid/liquid flow dividing at a T-junction it is important to appreciate the way in which the phases approach the junction. Stratified flows, stratified flows with a mixed layer at the interface (also referred to as three layer flow by e.g., Sunder Raj et al. (2005)) and dispersed flows have been observed. A number of papers have presented flow pattern maps for liquid/liquid flows. A systematic comparison between published flow pattern maps and experimental flow pattern data from the literature by Yang (2003) has shown that of Trallero et al. (1997) is the most accurate.

This paper provides data on the division of liquid/liquid flows at a junction where all pipes were horizontal. Both three layer and dispersed flows approaching the junction were studied.

2. Experimental arrangements

The experiments were carried out on a facility in the laboratories of the School of Chemical, Environmental and Mining Engineering, University of Nottingham which had been used previously for studies of phase separation for a junction with a vertically upwards side-arm (Yang et al., 2006), for measurements of drop sizes in liquid–liquid flows (Simmons and Azzopardi, 2001) and to examine the effect of bends on such flows (James et al., 2000).

A schematic diagram of the experimental system is shown in Fig. 1. Water and kerosene are pumped from their respective storage tanks, metered and introduced into a mixer. The flow rates of water and kerosene were metered by orifice plates, connected to differential pressure cells and controlled by valves, and bypass valves. In the mixer, the water is introduced axially whilst the kerosene was introduced into the test section through a large number of holes in the pipe wall which were angled downstream at 15° to the axis. The mixture flows along a 3.1 m long horizontal pipe to the T-junction. The run (the main pipe beyond the junction) is 2.0 m long and the side-arm 1.0 m long. All pipes are made of UPVC with internal diameters of 67.4 mm. There are valves to control the split of the flow at the ends of both outlets. Beyond these the flow enters a

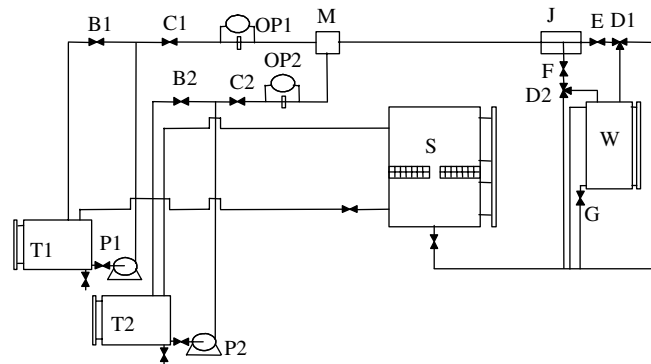

Fig. 1. Schematic diagram of liquid/liquid flow facility. T1,T2, storage tanks, OP1, OP2, orifice plates, B1,B2, bypass valves, C1, C2, valves, D1, D2, diverter valves, E, F, split control valves, G, emptying valve, J, T-junction, M, mixer, S, phase separator, W, measuring tank.

large phase separator, which is a vertical cylindrical vessel 2.5 m diameter and 2.4 m tall, containing 38, 0.15 m diameter by 1 m long coalescer cartridges. The flow from each of the two outlets could be diverted in turn by valves, for a fixed time into a measuring tank, where the phases were allowed to separate under gravity and the volumes measured. From this phase flow rates could be determined. This tank could be emptied using the valve at the bottom.

The liquids used in experiments were kerosene and deionised water whose properties are listed in Table 1.

All observations of phase split indicate that the behaviour of two-phase flow at a T-junction highly dependent upon the flow patterns approaching the T-junctions. Therefore, data have been taken for a number inlet flow rates covering the major flow patterns. Table 2 shows these conditions.

The superficial velocities of the kerosene and the water for these conditions are plotted on the flow pattern map of Trallero et al. (1997) as shown in Fig. 2. The flow patterns encountered were stratified with mixture at interface (three layer flow) or dispersed flows (both oil in water and water in oil according to the water cut). Most of the inlet conditions in Table 2 are designed to base on three different water cuts, i.e., nominally 75%, 55.6% and 26.5%. These conditions are represent different flow patterns because of the varied mixture velocities. In addition, by adjusting both outlet valves as shown in Fig. 1, the fractional mass take off can be

Table 1
Physical properties of liquids

	Kerosene	Deionised water
Density (kg/m^3)	796	998
Viscosity (kg/ms)	0.0021	0.001
Interfacial tension (N/m)	0.024	

Table 2
Inlet conditions for phase separation at the horizontal T-junction

#	Water superficial velocity u_{sw} (m/s)	Kerosene superficial velocity u_{sk} (m/s)	Mixture velocity u_m (m/s)	Water cut
1	0.40	0.32	0.72	55.6
2	0.24	0.19	0.43	55.8
3	0.40	0.15	0.55	72.7
4	0.64	0.22	0.86	74.4
5	0.15	0.41	0.56	26.8
6	1.35	0.45	1.8	75.0
7	1.63	1.97	3.6	45.3
8	0.68	2.03	2.71	25.1
9	1.0	0.34	1.34	74.6
10	1.55	1.08	2.63	58.9

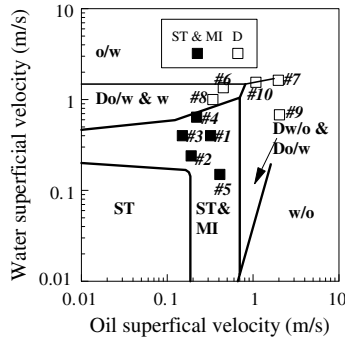

Fig. 2. Flow pattern of map of Trallero et al. (1997) showing inlet conditions for the experiments reported in this paper.

regulated to a desired value. Therefore, phase split results can be measured at different fractional mass take off, water cuts, and mixture velocities in different flow patterns.

3. Results

The flow patterns observed in the experiments reported here have been identified as either stratified with a mixed interface layer (three layer) or dispersed. In the former case, the fractional area occupied by each of the three layers, water, mixed layer and kerosene, have been quantified using direct observation of the interface positions. Example results for fixed water cut (55.6%) and constant mixture velocity (0.56 m/s) are shown in Figs. 3 and 4 which show that the fractional areas show little effect of mixture velocity but a, not surprising,

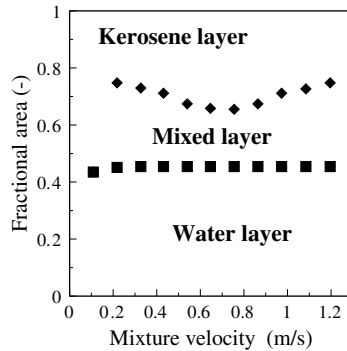

Fig. 3. Effect of mixture velocity on the fractional area occupied by each of kerosene layer, mixed layer and water layer. Water cut = 55%.

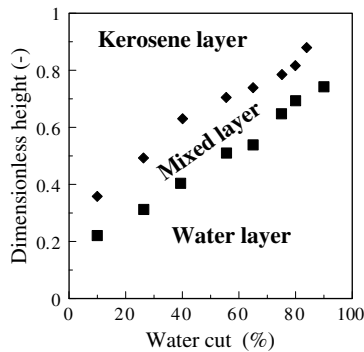

Fig. 4. Effect of water cut on position of interfaces between water and mixed layer kerosene. Mixture velocity = 0.56 m/s.

distinct effect of water cut. The measured phase splits are presented in Figs. 5–7. Here data are plotted as the fraction of incoming water emerging from the side-arm against the corresponding kerosene fraction. Fig. 5 shows data from the stratified with mixed interfacial layer runs. There is an effect of water cut but not of

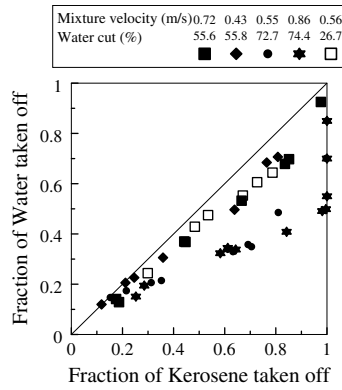

Fig. 5. Phase split of liquid/liquid flow when the incoming flow is stratified – runs #1–#5.

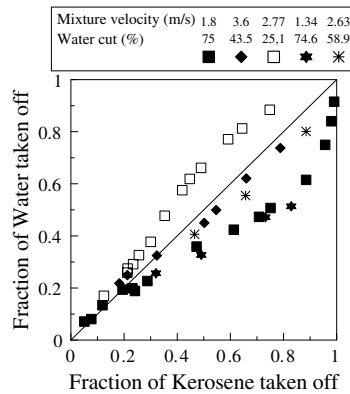

Fig. 6. Phase split of liquid/liquid flow when the incoming flow is dispersed – #6–#10.

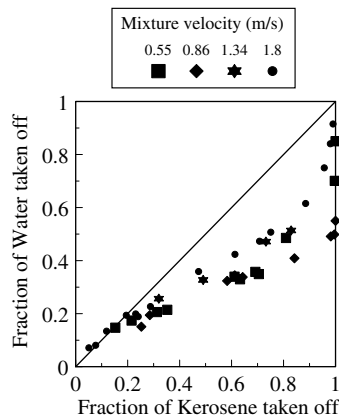

Fig. 7. Effect of mixture velocity on phase split at a water cut of 75%.

mixture velocity. The data from the dispersed area shown in Fig. 6 show a similar dependence on water cut but not mixture velocity. However, there is a difference if data for a given water cut it is considered, it can be seen that there is a trend with mixture velocity. However, this is not clear cut. There is little difference between the two lowest mixture velocities. Similarly, there is also only a small difference between the two highest.

4. Discussion

The simplest description of the mechanism of maldistribution is that the continuous phase will try and drag the dispersed phase into the side-arm whilst the dispersed phase tries to continue along the main pipe. This description holds for both the dispersed and three layer flows as the latter has a significant dispersed layer as shown in Figs. 3 and 4.

The phase split from those runs with dispersed flow at inlet might be expected to have similarities to the solid/liquid data of Nasr-El-Din et al. (1989). For both these flows the tendency for the dispersed phase to continue along the main pipe will probably be related to the momentum flux of that phase whilst the tendency to be taken off will be due to the drag of the continuous phase and hence its momentum flux. It should be possible to relate the phase maldistribution to the continuous/dispersed momentum flux ratio. Now, both the solid/liquid and dispersed liquid/liquid flows show slip ratios (continuous to dispersed velocity ratios) are close to 1.0; see Lovick and Angeli (2004) for the liquid/liquid case. Therefore the phase split might be expected to be proportional to the continuous/dispersed density ratio. For the solid/liquid case this takes a value of 0.4. For the liquid/liquid flow it is 0.8 when the kerosene is continuous and 1.2 when the water is continuous. For such comparisons, it is probably most useful to examine the maldistribution through the separation efficiency suggested by Yang et al. (2006). This relates the amount of take off to the best possible separation and can be calculated from

$$\eta(\%) = 100 * \text{abs}|K' - W'| \quad (1)$$

where K' is the fraction of incoming kerosene take off through the side-arm and W' is the corresponding fraction for water. This is usually plotted against the fraction of the total mass of incoming fluids emerging through the side-arm. Data taken from the work of Nasr-El-Din et al. (1989) for liquid/solids flows is shown in Fig. 8. The peak efficiency is $\sim 6\%$. Also shown in Fig. 8 are data from the present work. The oil in water data (diamonds) and water in oil data both have higher separation efficiencies than the liquid/solid data. As noted above the relative separations for these liquid/liquid cases are expected to be two or three times greater, i.e., about 12% and 18% for the kerosene or water continuous cases respectively. The data plotted in Fig. 8 shows peak values of 17% and 27%. Though these are slightly larger, they are of the correct order and mixture velocities were approximately the same in both the liquid/solid experiments of Nasr-El-Din et al. (1989) and the higher flow rate liquid/liquid shown in Fig. 8. It is pertinent to ask why is there little difference between the

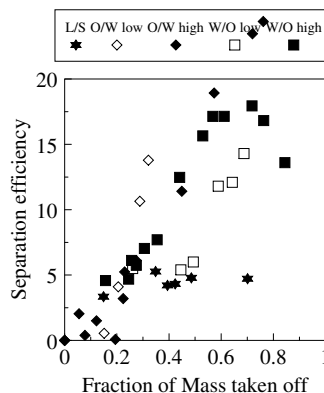

Fig. 8. Separation efficiency of liquid/solid data of Nasr-El-Din et al. (1989) and present liquid/liquid data. All data are for $\sim 25\%$ v/v dispersed phase. Low refers to a mixture velocity of 0.55 m/s and high corresponds to mixture velocities of 1.8–2.7 m/s.

dispersed and stratified cases, that is the high and low flow cases given in Fig. 8? One reason might be found in the work of Soleimani et al. (1999) and plotted in Fig. 9 which shows that the concentration is only uniform in the vertical direction at the highest mixture velocities. As seen there is a progression from stratified to full dispersed. The vertical distribution of water fraction can, to a first level, be described by

$$\varepsilon_w = \tanh \left\langle k \left[\left(\frac{y}{D} \right) - \left(\frac{h}{D} \right) \right] \right\rangle \tag{2}$$

where ε_w is the local water fraction, y is the distance from the pipe bottom, h is the position of the interface determined from the model of Taitel and Dukler (1976) if the flow were stratified, D is the pipe diameter and k is a constant. The equation gives reasonable fits to the data except in the upper layer of the intermediate velocity case. Now Lovick and Angeli (2004) suggested that there are two regions with water continuous in one whilst the organic phase is continuous in the other. The lack of gradient in the upper layer might indicate better dispersion in the kerosene than the water continuous part. The dispersed and three layer flow patterns might not be as distinct as first appears but are more part of a continuum, i.e., stratified merging smoothly to the dispersed.

Results for the horizontal side-arm are compared with the equivalent results of a case of a T-junction with a vertically upward side-arm in Fig. 10. For both cases the inlet superficial velocities are the same. The inlet conditions were: mixture velocity = 0.55 m/s and water cut = 75% resulting in a ST&MI or three layer flow pattern. Obviously, the T-junction with a horizontal side-arm is gives little maldistribution whilst the vertical upwards case shows a significant maldistribution.

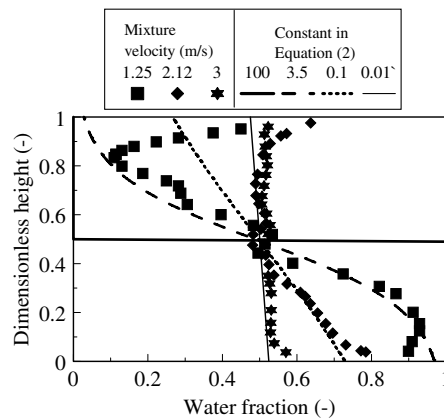

Fig. 9. Vertical variation of dispersed phase concentration taken from paper of Soleimani et al. (1999).

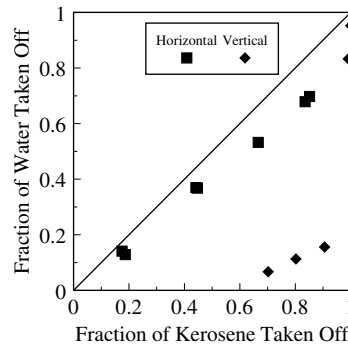

Fig. 10. Comparison of phase split from horizontal and vertically upwards side-arms.

Equivalent data has been sought for comparison within the large database available for gas–liquid division at T-junctions. Azzopardi (1999) noted that the actual momentum fluxes, those based on assuming that each phase flows in a part of the pipe with its own mean velocity, affected the phase split. The data with the most similar phase momentum fluxes are found in the air–water data of Buell et al. (1994) and the high-pressure steam–water data of Rubel et al. (1988). A comparison is shown in Fig. 11. Details of the inlet conditions for the gas–liquid data are tabulated in Table 3 which shows that the Buell et al. data are the closest in momentum flux and shows the best agreement in phase split. It is interesting that the velocities, both superficial and actual, and the void fraction are much different to those of the present data.

The available models for phase split at T-junctions were originally developed for gas/liquid two-phase flows. Obviously, for most gas/liquid flows the physical properties are significantly different from those of the present experiments tabulated in Table 3. In particular, it is the density ratio that is most different. Of the published gas/liquid data it is that published by the group from Karlsruhe, Germany, which is nearest to the present work. They worked with steam–water mixtures at pressures up to 100 bar. This has a density ratio of 12.5 compared to 1.25 in the present case. Though Seeger et al. (1986) did not develop a model for the maldistribution, they did produce a correlating equation which related the ratio of side-arm to inlet qualities to a fraction of mass take off.

Fig. 12 shows the comparison of the experimental results with the equation of Seeger et al. (1986). There is over prediction of the water take off at low kerosene take off and under prediction at higher off. Seeger et al. (1986) presented similar trends in their experimental results particularly at the highest pressures. That shows the closer the densities of the two-phases, the more difficult the phase separation at the junction with a horizontal branch. The prediction of Seeger et al. only fits the data at higher fractional mass take off.

From above comparison, it can be seen that no existing models can be directly applied to full range of the separation results for the liquid–liquid two-phase flow at the T-junction with a horizontal side-arm. The equation of Seeger et al. (1986) can be applied only at higher fractional mass take off.

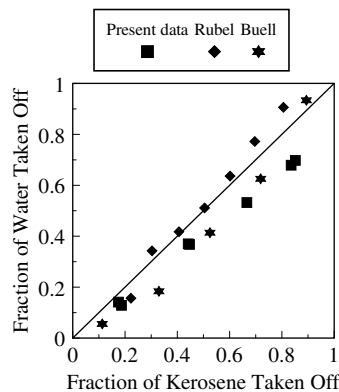

Fig. 11. Comparison of phase split data for gas/liquid and liquid/liquid flows. The cases were chosen to have the same momentum fluxes for each phase. Values shown in Table 3.

Table 3
Inlet conditions for gas–liquid data used in comparison

Source	Superficial velocities (m/s)		Momentum fluxes (kg/ms ²)	
	Gas	Liquid	Gas	Liquid
Present work run #1	0.32 ^a	0.4 ^b	724 ^a	717 ^b
Rubel et al. (1988) Steam/water 55 bar 95 mm diameter	4.8	0.025	472–527	618–640
Buell et al. (1994) Air/water 1.5 bar 38 mm diameter	18.3	0.0095	616	792

^a Kerosene liquid.

^b Water.

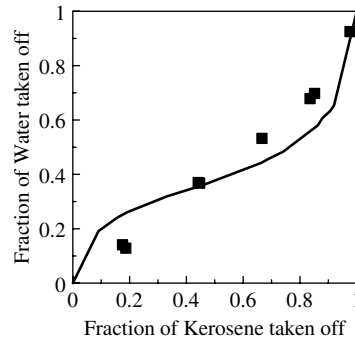

Fig. 12. Comparison between predictions of correlating equation of Seeger et al. (1986) and data from #1.

5. Conclusions

Kerosene–water two-phase flow has been investigated in a T-junction with equal pipe diameters, horizontal main pipe and side-arm. There is little phase maldistribution and hence this configuration of T-junction would not be efficient as a partial separator.

The comparison of the phase redistribution between the experimental results and correlating equation of Seeger et al. (1986) shows that these equations may be applied within certain range of operation conditions to liquid/liquid system.

References

- Azzopardi, B.J., 1999. Phase separation at T-junctions. *Multiphase Sci. Tech.* 11, 223–329.
- Buell, J.R., Soliman, H.M., Sims, G.E., 1994. Two-phase pressure drop and phase distribution at a horizontal tee junction. *Int. J. Multiphase Flow* 20, 819–836.
- James, P.W., Azzopardi, B.J., Graham, D.I., Sudlow, C.A., 2000. The effect of a bend on droplet size distribution in two-phase flow. In: *Proceedings of the seventh International Conferences on Multiphase Flow in Industrial Plants, Bolonga, Italy, 19–23 September*, pp. 211–222.
- Lempp, M., 1966. Die Strömungsverhältnisse von Gas-Feststoff-Gemischen in Verzweigungen Pneumatische Förderanlagen Aufbereitungs Technik 7, pp. 81–91.
- Lovick, J., Angeli, P., 2004. Experimental studies on the dual continuous flow pattern in oil–water flows. *Int. J. Multiphase Flow* 30, 139–157.
- Maeda, M., Ikai, S., 1976. Distributions of solid particles transported by air in branched lines. *Chem. Eng. Ronbunshu* 2, 25–30.
- Morikawa, Y., Kobayashi, Y., Takeda, M., Ueura, Y., 1974. Pressure losses of air–solid mixtures in the branching of pneumatic conveying. *Bull. JSME* 17, 1272–1277.
- Morikawa, Y., Kondo, T., Hiramoto, T., 1978. Pressure drop and solids distribution of air–solids mixture in a horizontal unsymmetric branches. *Int. J. Multiphase Flow* 4, 397–404.
- Müller, U., Reimann, J., 1991. Redistribution of two-phase flow in branching conduits: A Survey. In: *Proceedings of International Conferences on Multiphase Flows, Tsukuba, Japan, September 24–27*, pp. 85–107.
- Nasr-El-Din, H., Shook, C.A., 1986. Particle segregation in slurry flows through vertical tees. *Int. J. Multiphase Flow* 12, 427–443.
- Nasr-El-Din, H., Afacan, A., Masliyah, J.H., 1989. Solids segregation in slurry flow through a T-junction with a horizontal approach. *Int. J. Multiphase Flow* 15, 659–671.
- Reimann, J., Brinkmann, H.J., Domanski, R., 1988. Gas–liquid flow in dividing tee-junctions with horizontal inlet and different branch orientations and diameters. *Kernforschungszentrum Karlsruhe Report KfK 4399*.
- Rubel, M.T., Timmerman, B.D., Soliman, H.M., Sims, G.E., Ebadian, M.A., 1988. Phase distribution of high-pressure steam–water flow at a large diameter tee junction. *ASME J. Fluids Eng.* 116, 592–598.
- Seeger, W., Reimann, J., Müller, U., 1986. Two-phase flow in a T-junction with a horizontal inlet Part I: phase separation. *Int. J. Multiphase Flow* 12, 575–585.
- Simmons, M.J.H., Azzopardi, B.J., 2001. Drop size distributions in dispersed liquid–liquid pipe flow. *Int. J. Multiphase Flow* 27, 843–859.
- Soleimani, A., Lawrence, C.J., Hewitt, G.F., 1999. Spatial distribution of oil and water in horizontal pipe flow. *SPE Annual Technical conference and Exhibition, Houston, TX, pp. 343–358*.
- Sunder Raj, T., Chakrabarti, D.P., Das, G., 2005. Liquid–liquid stratified flow through horizontal conduits. *Chem. Eng. Tech.* 28, 899–907.

- Taitel, Y., Dukler, A.E., 1976. A model for predicting flow regime transitions in horizontal and near-horizontal gas–liquid flow. *AIChEJ* 22, 47–55.
- Trallero, J.L., Sarica, C., Brill, J.P., 1997. A study of oil–water flow patterns in horizontal pipes. *SPE Prod. Facil.*, 165–172.
- Yang, L., 2003. Liquid–liquid two-phase flows at T-junctions and through expansions. Ph.D. thesis, University of Nottingham.
- Yang, L., Azzopardi, B.J., Belghazi, A., Nakanishi, S., 2006. Phase separation of liquid–liquid two-phase flow at a T-junction. *AIChEJ* 52, 141–149.